

## BUD The 811 Mascot

***Hello!***

My name is BUD (Before You Dig),  
and I'm here to tell you about the  
811 Call Before You Dig System.

811 is the number you should call before  
you begin any digging project. By calling  
811 you will be helping your family,  
community and environment.



# 811



**Know what's below.  
Call before you dig.**

[www.call811.com](http://www.call811.com)

*Remember  
These Three  
Rules:*



## Safety Rules

### 1 Be Safe

Call Before You Dig! Either use the nationwide toll-free number 811 or your state specific toll-free number to contact your One Call Center!

### 2 Be Legal

In most states it's the law to call before digging!

### 3 Be a Good Neighbor

By working together we can keep our communities safe before, during and after digging projects!



• Know what's below.  
Call before you dig.

[www.call811.com](http://www.call811.com)

## REMEMBER!

Colored lines or flags paint a picture of what's below. Do not move or disturb the markings.



## Color-Coded Markers For Underground Utilities

<b>WHITE</b>	Proposed Excavation
<b>PINK</b>	Temporary Survey Markings
<b>RED</b>	Electric Power Lines, Cables or Conduit
<b>YELLOW</b>	Gas, Oil, Steam, Petroleum or Gaseous Materials
<b>ORANGE</b>	Communication, Alarm or Signal Lines, Cables or Conduit
<b>BLUE</b>	Potable (Drinkable) Water
<b>PURPLE</b>	Reclaimed Water or Irrigation Lines
<b>GREEN</b>	Sewers and Drain Lines



• Know what's below.  
Call before you dig.

[www.call811.com](http://www.call811.com)

# Urban Underground Utility Examples

- 1 Electric Power Lines, Cables or Conduit
- 2 Gas, Oil, Steam, Petroleum or Gaseous Materials
- 3 Communication, Alarm or Signal Lines, Cables or Conduit
- 4 Potable (Drinkable) Water
- 5 Sewers and Drain Lines

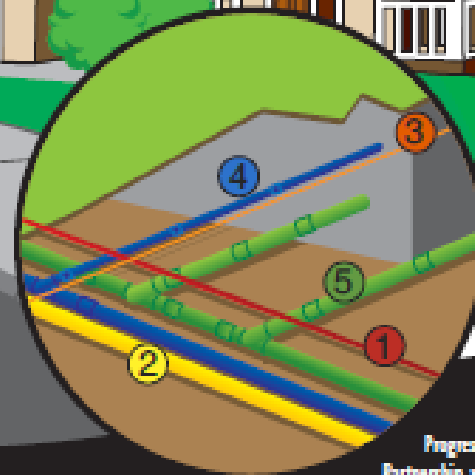

Know what's below.  
Call before you dig.

[www.call811.com](http://www.call811.com)

Progressive Agriculture Safety Day in  
Partnership with Common Ground Alliance  
© 2008 Common Ground Alliance

# Rural Underground Utility Examples

- 1 Electric Power Lines, Cables or Conduit
- 2 Gas, Oil, Steam, Petroleum or Gaseous Materials
- 3 Communication, Alarm or Signal Lines, Cables or Conduit
- 4 Potable (Drinkable) Water
- 5 Sewers and Drain Lines

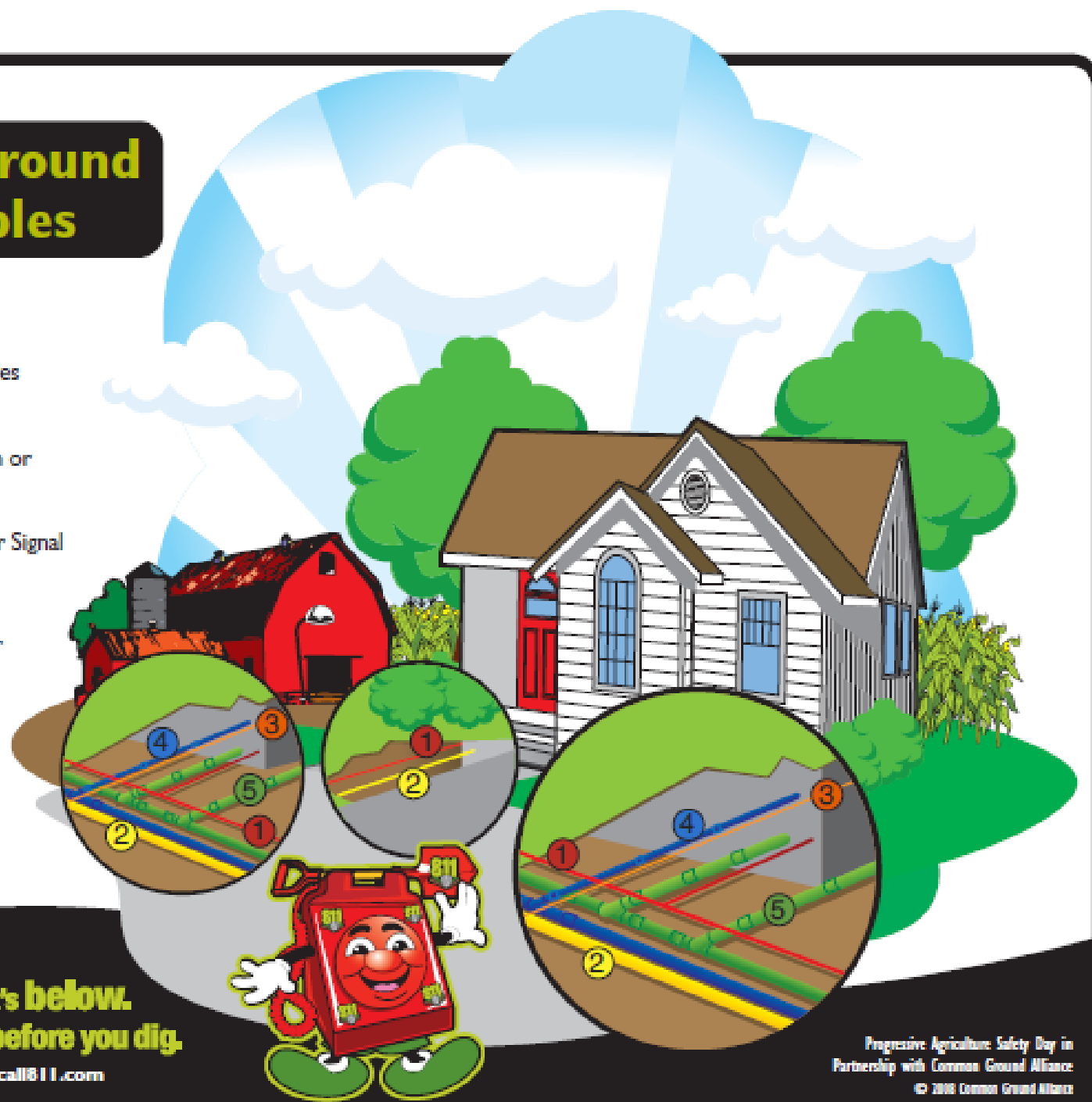

# 811

Know what's below.  
Call before you dig.

[www.call811.com](http://www.call811.com)

Progressive Agriculture Safety Day in  
Partnership with Common Ground Alliance  
© 2018 Common Ground Alliance

# REMEMBER!

Colored lines or flags paint a picture of what's below.  
Do not move or disturb the markings.

## Indicators For Various Underground Utilities



• Know what's below.  
Call before you dig.

# Sample Underground Utility Markers

*When you see aboveground signs or posts, the sign shows that a utility of some type is buried close by. It always has an emergency phone number, and often a reminder to call 811.*

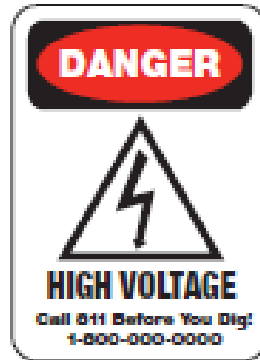
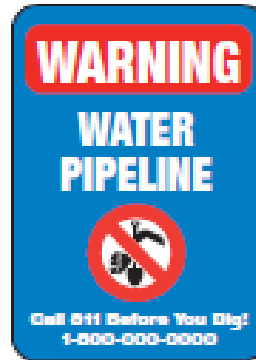
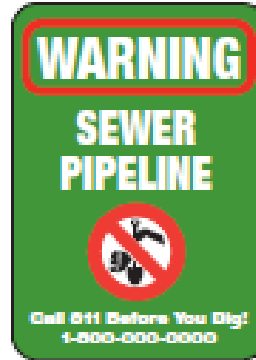
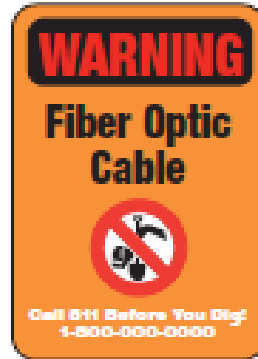
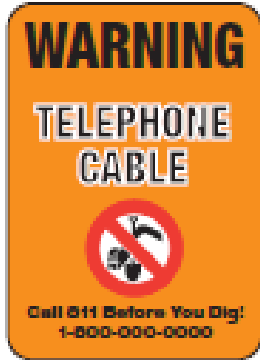

Know what's below.  
Call before you dig.

[www.call811.com](http://www.call811.com)

*Use your senses.  
Sight, sound and  
smell can help you  
detect a leak.*



Know what's below.  
**Call before you dig.**

[www.call811.com](http://www.call811.com)

## Signs of a Pipeline Leak



### SIGHT

- Dirt or debris blowing into the air.
- Continual bubbling in a pond, river or creek.
- Plants that seem to be dead or dying.
- Pool of liquid on the ground.
- A dense white cloud, fog, or mist.
- An oily sheen on water surfaces.
- Frozen ground in warm weather.



### SOUND

- A hissing sound or loud noise like the sound of a jet engine or an airplane.



### SMELL

- An unusual smell or strange odor.

### Actions To Take When Utilities Are Damaged Or Found Disturbed

1. Immediately leave the area on foot.
2. Tell an adult what you saw or heard.
3. Ask the adult to call 911.
4. Ask the adult to help keep others away from the area.
5. Do not use anything that will create a flame or spark, such as matches, lighters, flashlights, cell phones, cameras, or start any type of vehicle or machinery.

# Certificate of Completion

**UNDERGROUND UTILITY  
SAFETY  
CHAMPION**

Name: \_\_\_\_\_

Date: \_\_\_\_\_

***Congratulations!  
You get first place  
for safety!***



• Know what's below.  
Call before you dig.

[www.call811.com](http://www.call811.com)

Progressive Agriculture Safety Day in Partnership with Common Ground Alliance

© 2008 Common Ground Alliance

## Dot-to-Dot

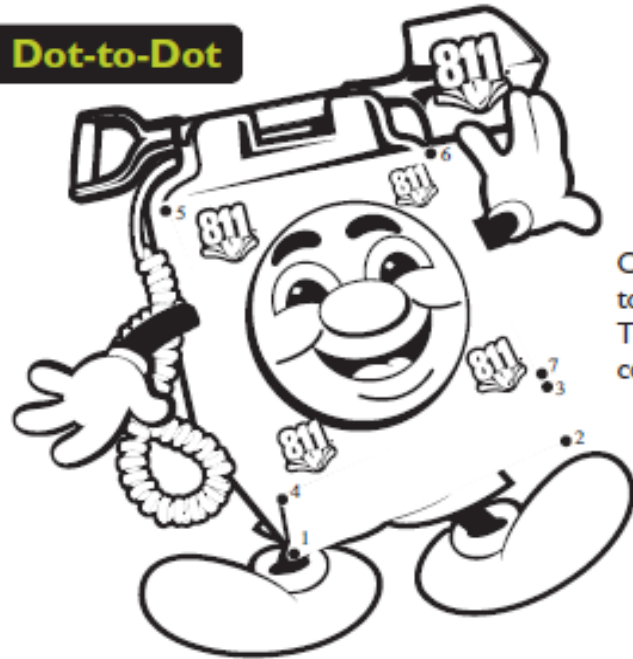

Connect the dots to complete BUD. Then you can color him.

## Fun & Games

## Word Scramble

Use the letters to finish a 4 word message from BUD!

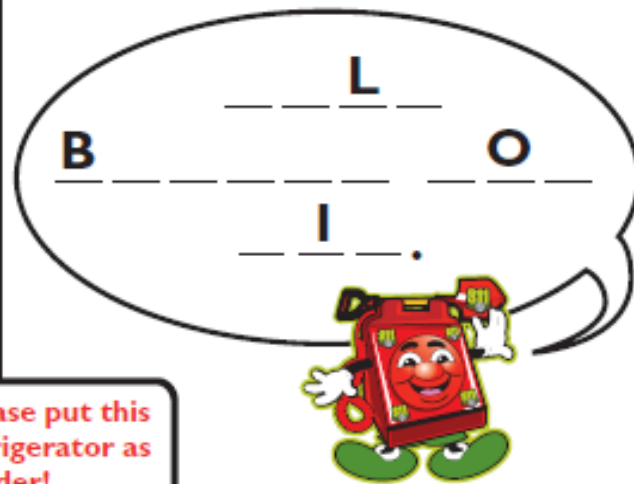

A E  
O Y  
L D  
G R  
F U  
E C

Answer: Call Before You Dig.

Parents please put this on your refrigerator as a fun reminder!



Start

Help BUD find his way through the maze of utilities.

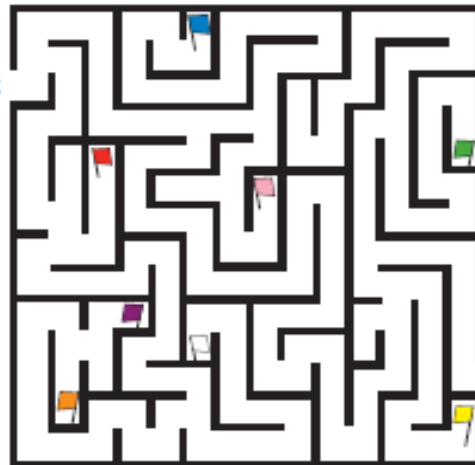

Finish

## Maze Puzzle

Draw a line from the utility to the correct colored flag marker.

## Match Game



Proposed Excavation  
Temporary Survey  
Gas  
Communication  
Electric  
Water (Drinkable)  
Irrigation Line  
Sewer



Proposed Excavation: White • Temporary Survey: Pink • Gas: Yellow  
Communication: Orange • Electric: Red • Water (Drinkable): Blue • Irrigation Line: Purple • Sewer: Green



Know what's below.  
Call before you dig.

www.call811.com

Progressive Agriculture Safety Day in Partnership with Common Ground Alliance

© 2008 Common Ground Alliance

## 811 Coloring Book

Let's have  
fun coloring  
our way  
to safety!



# 811



Know what's below.  
Call before you dig.

[www.call811.com](http://www.call811.com)

811 is the number  
you should call before  
you begin any digging  
project. By calling 811 you  
will be helping your  
family, community and  
environment.

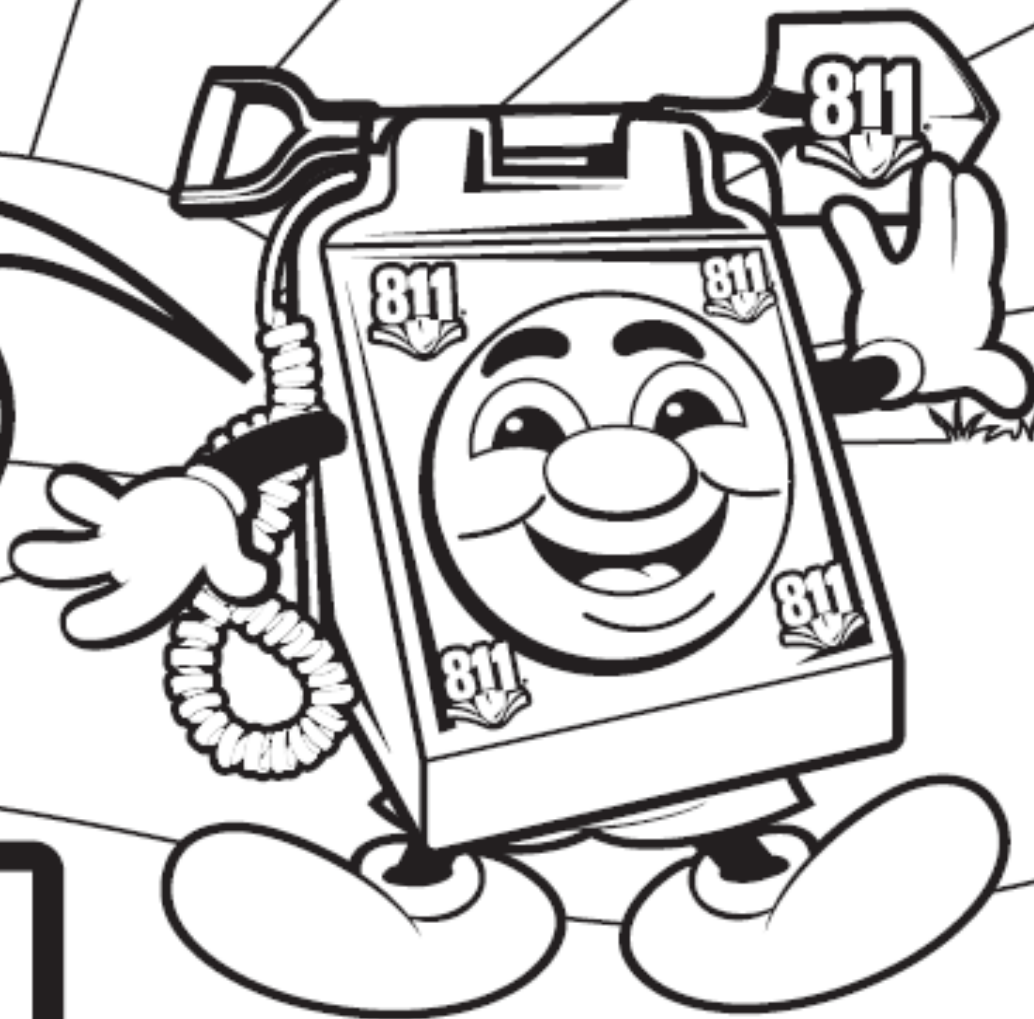

Know what's below.  
Call before you dig.

[www.call811.com](http://www.call811.com)

**B4UGoB-Lo Rap**

*No slice is right,  
So now you know  
To call 8-1-1  
Before you  
“go below.”*



**Know what's below.  
Call before you dig.**

[www.call811.com](http://www.call811.com)

Progressive Agriculture Safety Day in Partnership with Common Ground Alliance  
© 2008 Common Ground Alliance

# Rural Underground Utility Examples

- 1 Electric Power Lines, Cables or Conduit
- 2 Gas, Oil, Steam, Petroleum or Gaseous Materials
- 3 Communication, Alarm or Signal Lines, Cables or Conduit
- 4 Potable (Drinkable) Water
- 5 Sewers and Drain Lines

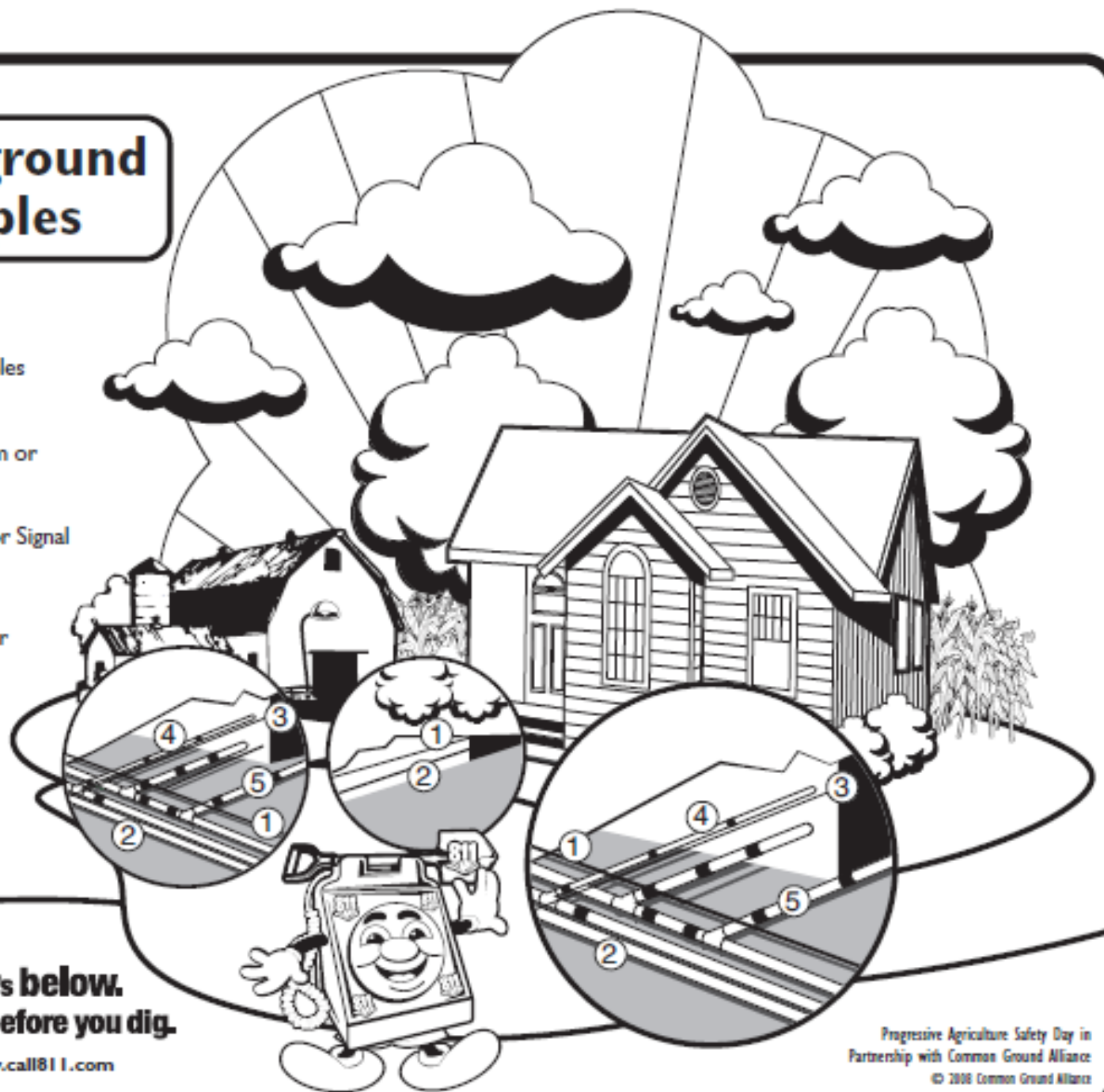

**Know what's below.  
Call before you dig.**

[www.call811.com](http://www.call811.com)

Progressive Agriculture Safety Day in  
Partnership with Common Ground Alliance  
© 2008 Common Ground Alliance

# Urban Underground Utility Examples

- 1 Electric Power Lines, Cables or Conduit
- 2 Gas, Oil, Steam, Petroleum or Gaseous Materials
- 3 Communication, Alarm or Signal Lines, Cables or Conduit
- 4 Potable (Drinkable) Water
- 5 Sewers and Drain Lines

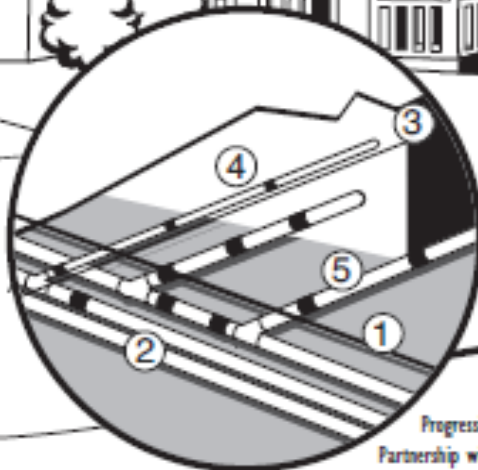

Know what's below.  
Call before you dig.

[www.call811.com](http://www.call811.com)

Progressive Agriculture Safety Day in  
Partnership with Common Ground Alliance  
© 2008 Common Ground Alliance

# REMEMBER!

*Colored lines or flags paint a picture of what's below. Do not move or disturb the markings.*

## Indicators For Various Underground Utilities

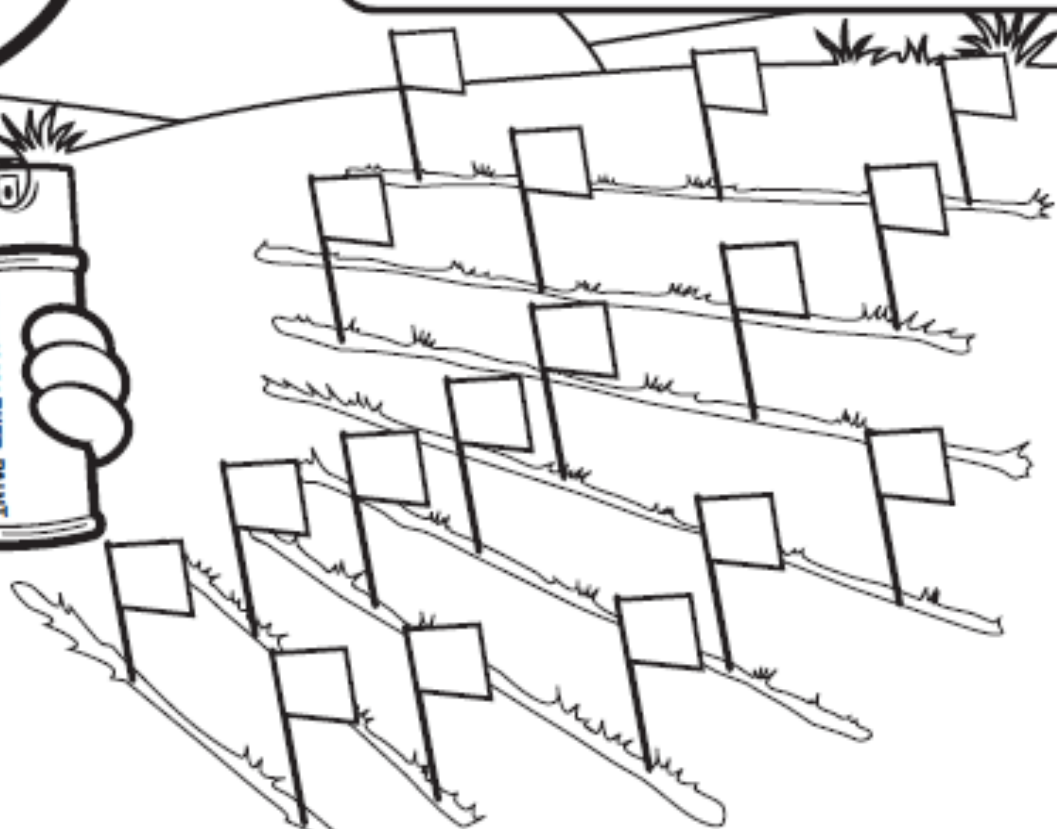

Know what's below.  
Call before you dig.

[www.call811.com](http://www.call811.com)

## REMEMBER!

*Colored lines or flags paint  
a picture of what's below.  
Do not move or disturb  
the markings.*

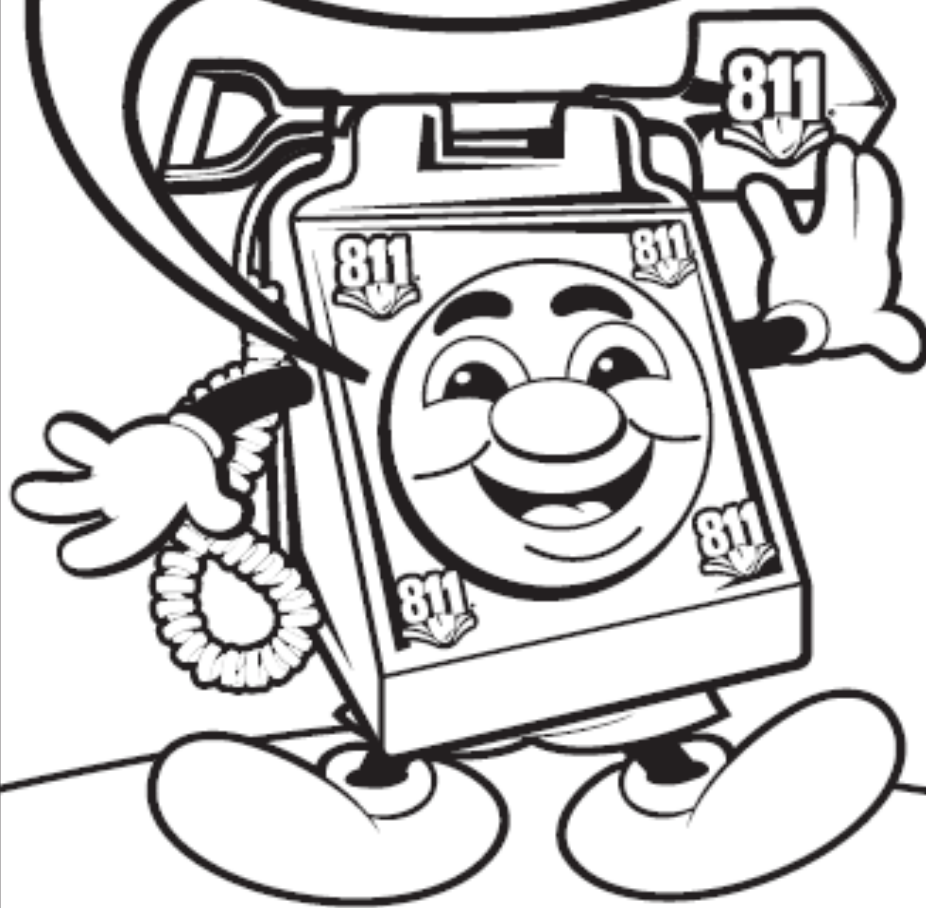

## Color-Coded Markers For Underground Utilities

**WHITE** Proposed Excavation

**PINK** Temporary Survey Markings

**RED** Electric Power Lines, Cables or Conduit

**YELLOW** Gas, Oil, Steam, Petroleum  
or Gaseous Materials

**ORANGE** Communication, Alarm or Signal  
Lines, Cables or Conduit

**BLUE** Potable (Drinkable) Water

**PURPLE** Reclaimed Water or  
Irrigation Lines

**GREEN** Sewers and Drain Lines



Know what's below.  
Call before you dig.

[www.call811.com](http://www.call811.com)

**You Never  
Know What's  
Below.**



***REMEMBER!***

811 is the number  
you should call  
before you begin  
any digging project.

Smart digging means  
calling 811 before  
each job. Whether you  
are a homeowner or a  
professional excavator,  
one FREE call to 811  
gets your underground  
utility lines marked  
for FREE.

**Know what's below.  
Call before you dig.**